

Article number: 3918049036327

Description: Worm gear with st. steel hollow shaft  
VF 49 EP-V-36- 71B5

## Measures

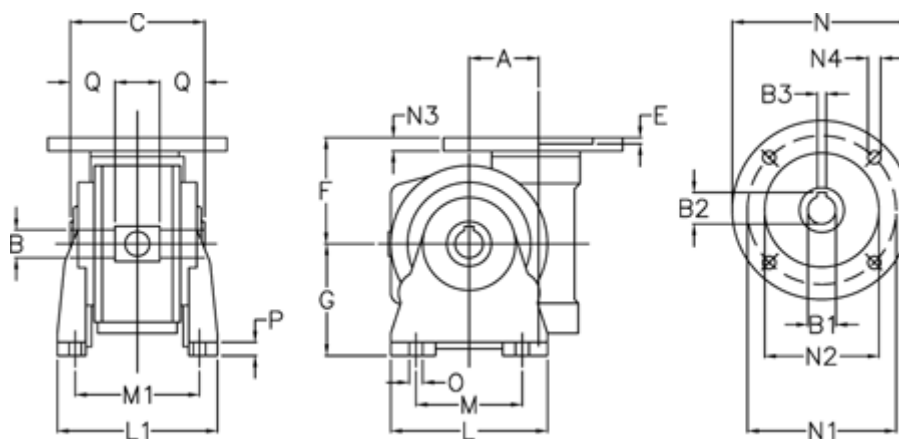

a	= 49.5	g	= 82	N3	= 10.5
B	= 25	L	= 110	N4	= 9.5
B1 E7	= 14	L1	= 124.0	O	= 8.5
B2	= 16.3	m	= 63	P	= 12
B3 H9	= 5	M1	= 98.5	Q	= 22.5
C	= 82	N	= 160		
E	= 3.0	N1	= 130		
F	= 70	N2	= 110		